

**NOTES**

All levels and dimensions in metres unless otherwise specified

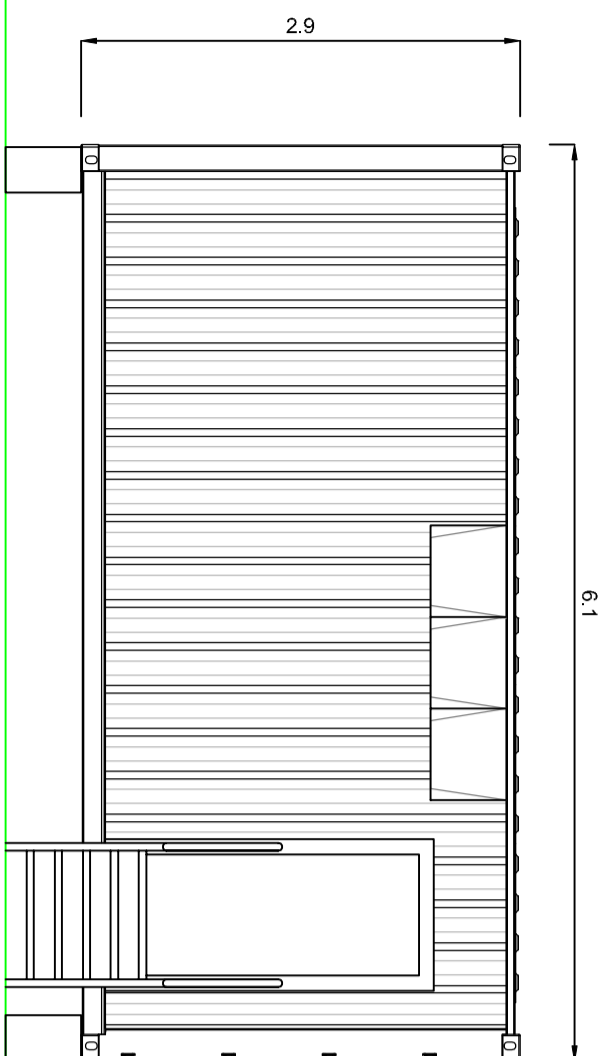

Front Elevation  
Typical Inverter

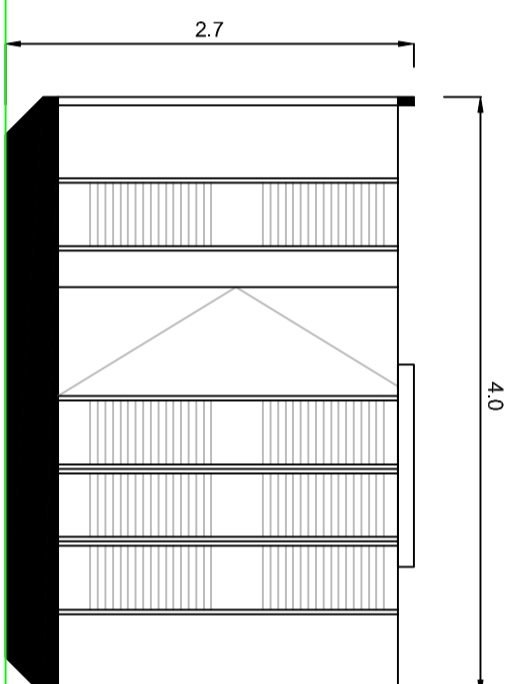

Front Elevation  
Typical Transformer

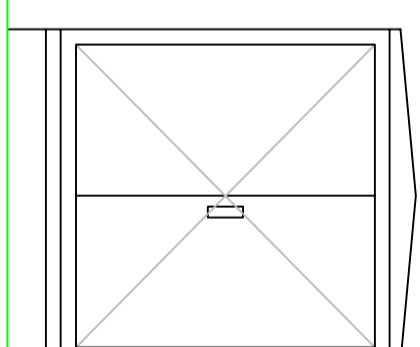

Side Elevation (Door)  
Typical Transformer

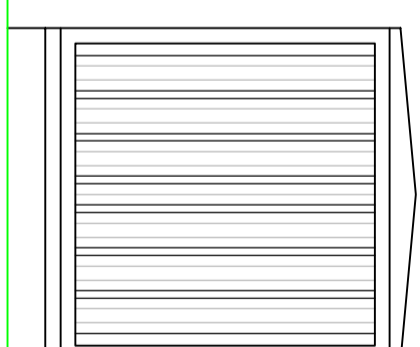

Side Elevation (Solid)  
Typical Transformer

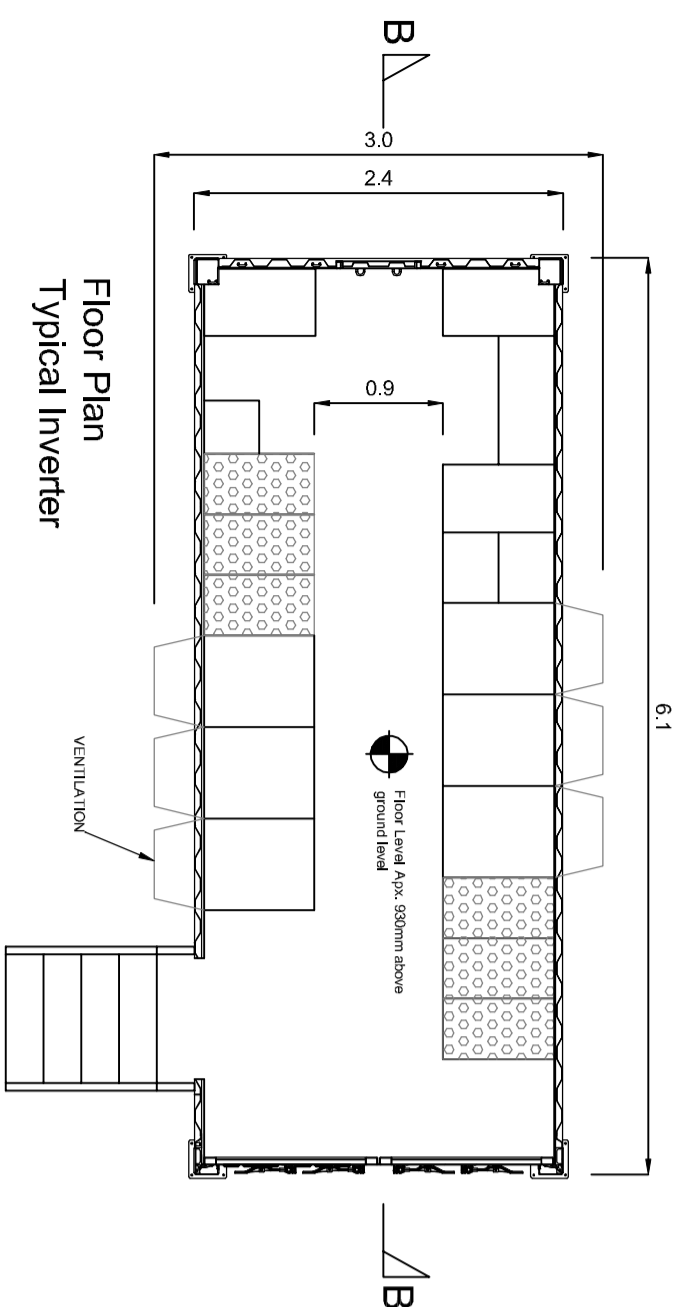

Floor Plan  
Typical Inverter

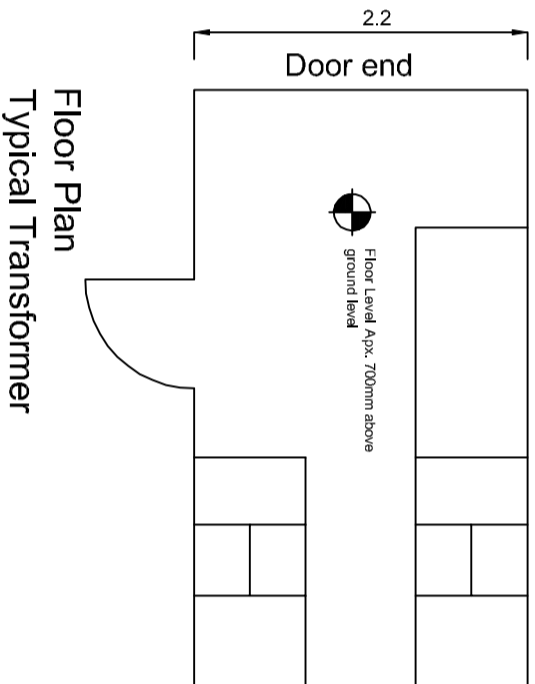

Floor Plan  
Typical Transformer

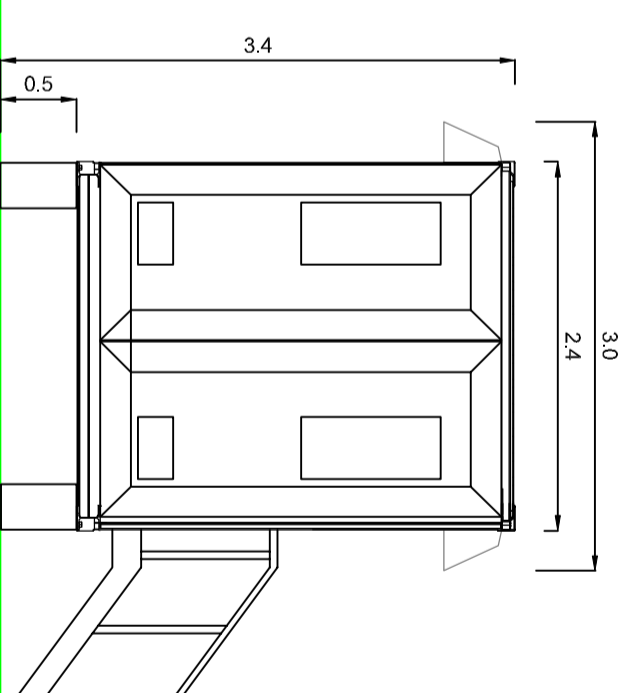

Side Elevation (Door)  
Typical Inverter

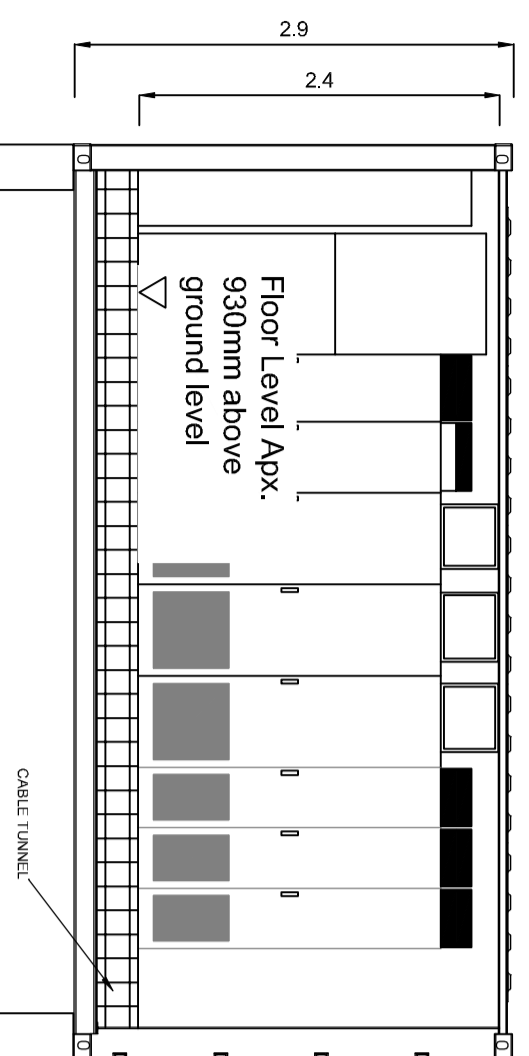

Section B - B  
Typical Inverter

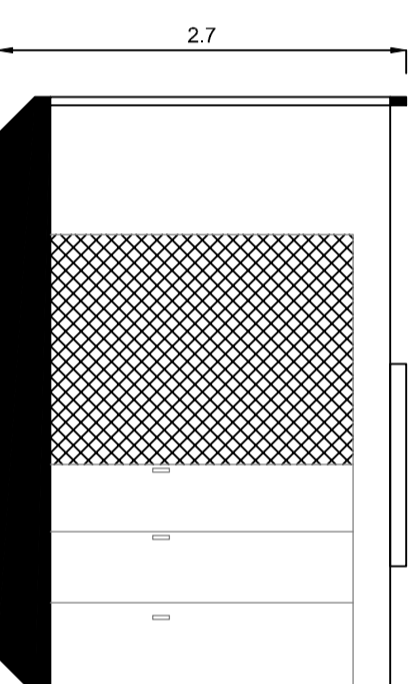

Section A - A  
Typical Transformer

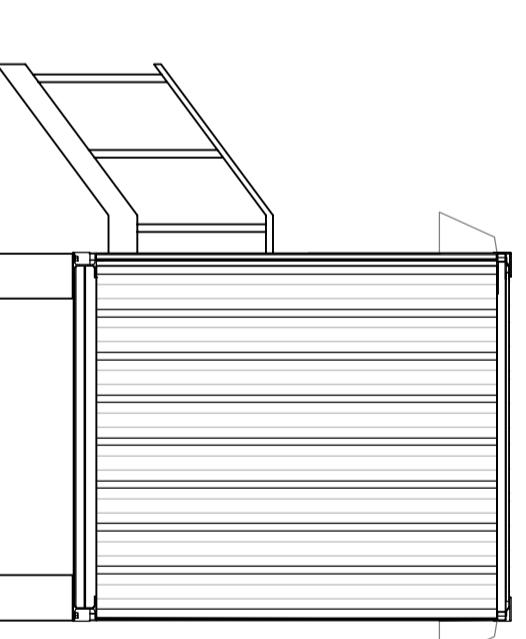

Side Elevation (Solid)  
Typical Inverter

Scale (@ A2) 1:50

Date: 14 NOV 2018

Prepared by:



Client: Awel Aman Tawe

Project: Mynydd Y Gwrhyd Solar Farm

Figure 3-4 Option 2:  
Separate Inverter / Transformer

Dulas ref:  
E05419

Drawn by: DR

Checked by: RK

Version: B

Every effort has been made to ensure the accuracy of the information provided on this figure. Dulas cannot be held responsible for any omissions or errors in the information provided. Dulas accepts no liability for any loss or damage, responsibility for any losses, disengagement, negligence or damage caused by reliance on the information contained on this figure.

